

Luxman

INTEGRATED AMPLIFIER

L-550AX

*Owner's Manual*

---

## Contents

Precautions .....	1
Features of This Unit .....	2
Names and Functions .....	4
Connections .....	12
Operations .....	16
How to Use Remote Control .....	18
Block Diagram .....	20
Specifications .....	21
Before Asking for Repair Services .....	22

---

# Precautions

*Luxman*  
INTEGRATED AMPLIFIER L-550AX

## Installation place

This unit shall be installed in a well-ventilated and effectively heat-released place because this unit is an A-class amplifier and generates considerable heat.

Especially, installation of this unit where direct sunlight is present, where the temperature rises excessively high such as close to a heater, or where it is humid or dusty may cause a malfunction even if heat is efficiently released. Therefore, do not install this unit in such places.

## Ventilation holes

The ventilation holes on the top and bottom boards of this product must not be blocked because this unit is an A-class amplifier and generates considerable heat. If the amplifier is installed on a rack or the like, secure ample space for cooling and leave the door open. Do not pile up other things on the amplifier and never put articles on it. Failure to observe this may cause a malfunction.

### Note:

For heat dispersal, do not install this equipment in a confined space such as a book case or similar unit.

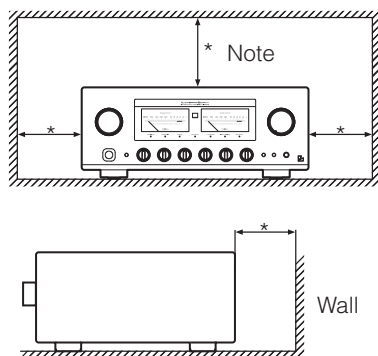

## Precautions in connecting with other components

When connecting this unit to input devices such as a CD player, an SACD player, a tuner, and a recorder, be sure to turn off the power of this unit and all other connected devices. Failure to observe this may generate a strong noise resulting in speaker damage or cause a malfunction.

The pin-plug to be inserted in each input terminal of this unit shall be pushed in firmly. If the grounding terminal is inadequately connected, noises including hum may be generated, resulting in an adverse S/N ratio.

## Cautions in connecting speakers

When making speaker system connections, exercise extra care not to short-circuit between  $\oplus$  and  $\ominus$  of the speaker terminals and speaker input terminals of this unit. If a large signal is applied to the amplifier with its circuit left short-circuited, a large current may be passed through the output circuit and cause a malfunction.

## The sound is not generated shortly after the power supply is turned on.

This amplifier is equipped with a time muting circuit in order to separate the output circuit. Therefore, no sound is generated shortly after the power supply is turned on.

If the volume control is moved to a high sound level before the time muting circuit is canceled, a large sound is suddenly generated. Please be advised that the volume control shall be set to a low level at first and adjusted after sound comes out of the speakers.

## Protection circuit

This product is equipped with a protection circuit that is activated upon detection of overcurrent, abnormally high temperature, and DC drift to protect the amplifier and speakers. When the protection circuit is activated, the output to the speaker terminal is shut off and the standby indicator blinks to show that this unit is in the muting state. If the protection circuit is frequently activated even when disconnecting the power plug from the wall outlet and turning on the power again after a lapse of a certain time, please consult your dealer.

## Batteries

### Caution:

Batteries used for remote controller shall not be exposed to excessive heat such as sunshine, fire or the like.

## Repair and adjustment

When repairs or adjustments are needed, please ask the dealer where you bought the unit.

## Cleaning

For cleaning, use a piece of soft cloth to wipe the unit such as cleaning cloth available on the market. If the unit has become very dirty, remove the dirt with soft cloth absorbing a small amount of neutral detergent, and then wipe the unit with dry cloth. Do not use a solvent like benzine or thinner because such a substance can often damage the exterior.

# Features of This Unit

## **LECUA-WM - LUXMAN Electric Controlled Ultimate Attenuator - Waiting Matrix**

Application of the system to obtain attenuation by combining 2 fixed resistances connected to this product series has improved efficiency of the LECUA1000 attenuator used in our flagship model, C-1000f.

The shortest signaling route has been achieved by the integrated amplifier circuit thanks to the 3D structure of the mounting boards.

Controlling LECUA-WM to the level equal to the volume position detected by a microprocessor has achieved the operation feeling similar to our conventional sliding-type volume controls.

## **ODNF - Only Distortion Negative Feedback -**

The amplification feedback circuit that has acquired the high-speed primary slew rate and ultra-high bandwidth by feeding back only distortion components generated during amplification to maintain the pure sound quality of the main-amplifier that is almost non-feedback.

The newest version, 3.0A, has achieved the low impedance and high S/N ratio of the transmission circuit by parallelization of the first and second stages of the amplifier circuit.

In addition, the input stages of the error detection circuit are parallelized to moderate the frequency characteristic and noise.

## **2 parallel push-pull output stages**

2 parallel push-pull structure of bipolar transistor.

Pure class A rated output 20W+20W (8Ω).

## **High-inertia power supply**

High-inertia electronic circuit that combines a large-capacity EI-core-type power transformer with customizable 10,000μF × 4 capacitor blocks.

## **Parallel speaker relays**

This unit is equipped with large type of 2 parallel speaker relays with a low resistance value to reduce the impedance of the speaker output lines.

## **Beeline construction**

Newly designed beeline construction composes the audio input signal via the optimally shortest route to the speaker output.

## **Selector switch IC**

Selector switch IC with high sound quality, which is used in the top-end control amplifier, C-1000f, improves the separation and crosstalk performances.

## **Schottky barrier diode**

Application of schottky barrier diode manufactured by Nihon Inter Electronics Corporation that has less switching noises and higher conversion efficiency to the DC voltage for the power supply rectifier circuit.

## **LUXMAN's original OFC wires**

Our original OFC wires are used in the internal wiring to achieve smooth signal transmission thanks to the spiral wrap shielding on each core and the non-plating process on the core wire.

### **Round pattern board**

After careful consideration of delicate audio signal flow, a round pattern board has been applied to achieve smooth signal transmission.

### **Phono amplifier**

This unit is equipped with a phono amplifier that is compatible with the MM/MC cartridge to achieve analog record reproduction in a high-grade level without adding a dedicated phono amplifier.

### **Separate function**

This unit is equipped with a separate switch to separate the pre-amplifier and power-amplifier each other that enables the bi-amp connection adding a power-amplifier and the coexistence with an AV system.

### **Loopless chassis structure**

This unit consists of the independent construction of a loopless chassis to eliminate increased ground impedance caused by chassis current.

### **18 mm pitch RCA terminal**

Introduction of 18 mm pitch all RCA input/output terminals allows even a high-performance line cable with large plug to be connected.

### **Large type of speaker terminals**

Speaker terminals (A and B systems) of inline layout (with same characteristics for right and left), which is compatible with Y lugs and banana plugs to enable easy connection with extra-thick speaker cables.

### **New standard size**

This unit has been manufactured based on LUXMAN's new standard size (440mm wide, common with a series of separate amplifiers and a series of SACD players).

### **Headphone output terminal**

This terminal allows you to casually enjoy sound even at midnight.

### **AC inlet**

This inlet enables the connection with an external power cable.

### **Needle-type meter**

This unit is equipped with needle-type meters lighted with LED, which improves the visibility in the room where the unit will be installed.

### **Remote control encased in aluminum**

The high-grade remote control, which is encased in aluminum, can control applicable CD/SACD players.

# Names and Functions

## Front panel

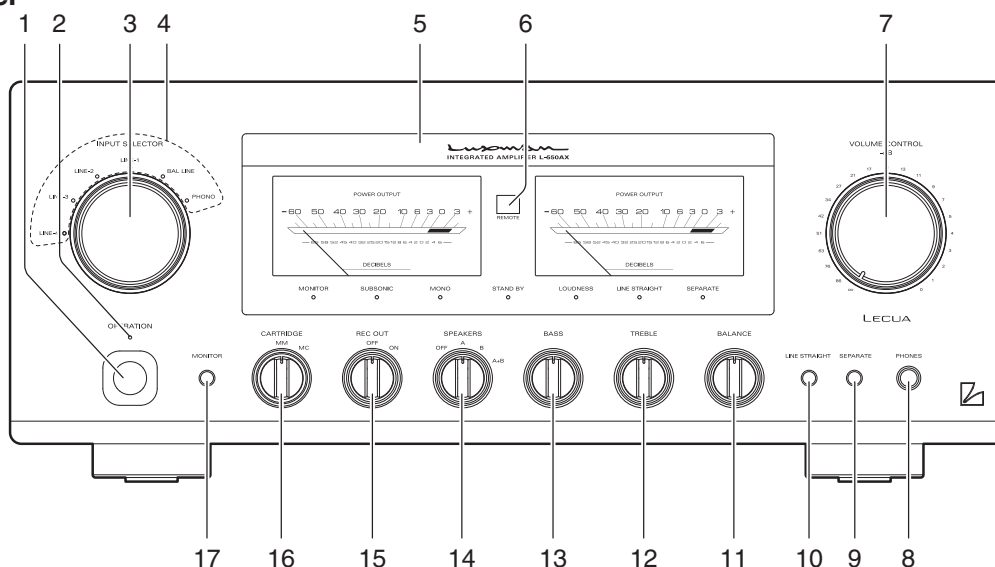

### 1. Operation switch (OPERATION)

Toggles the power on and off.

When wiring or connection is performed, be sure to turn off this switch.

### 2. Operation indicator (OPERATION)

Blinks in the time of muting mode when the operation switch is turned on and lights up when the operation state is activated afterward. This indicator blinks when the unit is in the muting mode or when the volume is adjusted with the remote control.

### 3. Input selector (INPUT SELECTOR)

Selects an input device from the devices such as a CD player, an SACD player and a tuner connected to each input terminal.

The input selector has 6 positions consisting of LINE-4, LINE-3, LINE-2, LINE-1, BAL LINE, and PHONO from left to right that correspond to each input terminal on the rear panel. The knob is rotated to light the input indicator of the input device to be selected.

### 4. Input indicator

Lights up at the input device to be selected with the input selector or remote control.

## 5. Display

Displays the operation status of this unit.

This display is composed of 7 indicators and 2 power meters.

## 6. Remote control infrared receiver (REMOTE)

This is a sensor to receive signals from the accessory remote control.

## 7. Volume control (VOLUME CONTROL)

Adjusts the sound volume. Sound is not generated when this control is rotated counterclockwise to the end, and then, the sound volume gradually becomes higher when the control is slowly rotated clockwise.

## 8. Headphone jack (PHONES)

Insert the headphone plug into this output jack. Even when the plug is inserted, signals to the speaker output terminal are not interrupted. Accordingly, to listen to sound with only use of headphones, set the speaker selector to off.

## 9. Separate switch (SEPARATE)

Separates the pre-amplifier and main-amplifier each other.

off :                    Uses this unit as a normal pre-main amplifier.  
(separate  
indicator off)

on :                    Feeds external signals from the MAIN IN terminal on the rear panel to the main-amplifier section.

- Every pressing of this switch toggles the separate on and off.

The separate indicator lights up when the separate switch is on.

---

**When the separate switch is set to on, the volume control of this unit cannot adjust the volume of the speakers connected to this unit. Volume adjustment shall be performed at the input device side such as the control amplifier connected to the MAIN IN terminal.**

**Entry of direct output into the MAIN IN terminal from a CD player or other devices that cannot adjust sound volume constantly provides a full power state and accordingly results in the risk of speaker damage.**

**For such input devices, be sure to use a control amplifier equipped with the sound volume adjustment function as a relay, generate sound through the speakers with volume lowered, and adjust the volume to your favorite level.**

**When arranging the wiring, be sure to turn off the power of this unit.**

---

# Names and Functions

## Front panel

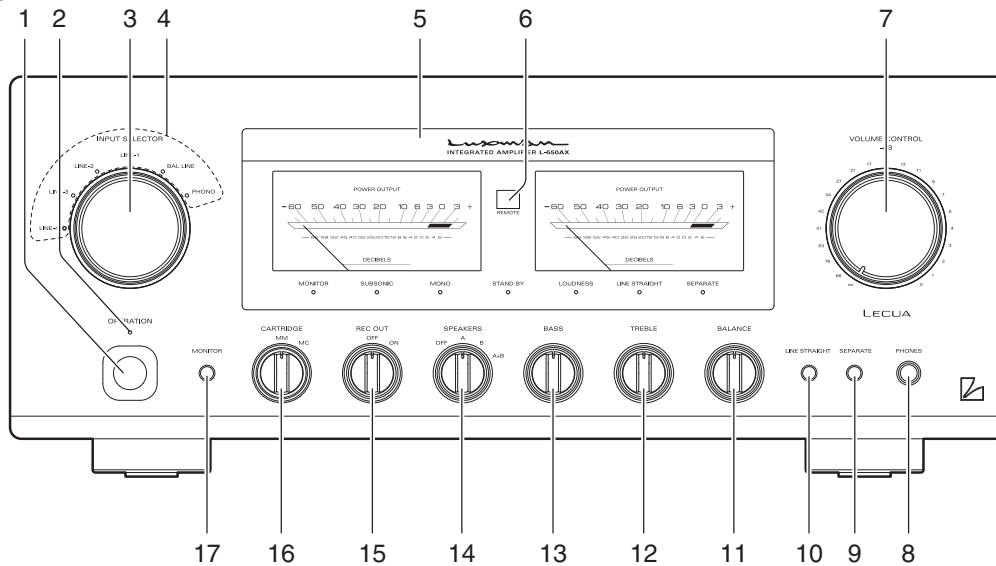

### 10. Line straight switch (LINE STRAIGHT)

Enhances the purity of the sound quality by bypassing the balance control circuit, tone control circuit, or the like.

off : Line straight off/bypass off  
(line straight indicator off)

on : Line straight on/bypass on  
(line straight indicator on)

- Every pressing of this switch toggles the line straight on and off.

The line straight indicator lights up when the line straight switch is on.

---

**When the line straight switch is set to on, the balance control, tone control, subsonic, monaural and loudness cannot be adjusted and the mode selector does not function.**

---

### 11. Balance control (BALANCE)

Adjusts the balance of sound volume between right and left channels.

Rotating this switch counterclockwise causes the left sound volume to be enhanced, and rotating the switch clockwise causes the right sound volume to be enhanced.

This switch shall be set to the center position under normal conditions, and rotated to make adjustment if necessary.

When the line straight switch is set to on, this switch does not function.

### 12. Tone control for treble (TREBLE)

Controls the frequency characteristics in the high-frequency range.

When this switch is set to the center position, flat frequency characteristic is obtained. Rotating the switch clockwise causes the high-frequency range to be enhanced, and rotating the switch counterclockwise causes the high-frequency range to be attenuated.

When the line straight switch is set to on, this switch does not function.



### 13. Tone control for bass (BASS)

Controls the frequency characteristics in the low-frequency range.

When this switch is set to the center position, flat frequency characteristic is obtained. Rotating the switch clockwise causes the low-frequency range to be enhanced, and rotating the switch counterclockwise causes the low-frequency range to be attenuated.

When the line straight switch is set to on, this switch does not function.

### 14. Speaker selector (SPEAKERS)

Selects either of 2 speaker systems, A or B, located at the rear panel.

OFF: Activates only headphones. No sound is generated from any speakers.

A: Selects the A system speaker terminal.

(center)

B: Selects the B system speaker terminal.

A+B: Simultaneously activates both A and B system speakers. When both speaker terminals are simultaneously used, select speakers with impedance of 8 ohms or more because both output terminals are connected in parallel.

### 15. Recording switch (REC OUT)

Sends recording signals to the recorder connected to this unit.

OFF: Does not send recording signals to the recorder output terminals on the rear panel.

When not using the recorder, set the recording switch to this position.

ON: Selects an input source to be recorded with the input selector and sends recording signals to the recorder connected the recorder output terminals of this unit.

### 16. Cartridge selector (CARTRIDGE)

Changes the gain level of the equalizer amplifier (amplifier circuit required to play an analog record).

MC: Selects an MC (moving coil) type cartridge of low output voltage.

Be aware that the sound volume becomes higher and unbalanced sound without high frequencies is generated owing to the impedance when "MC" is selected during use of the MM type cartridge.

MM: Selects an MM (moving magnet) type cartridge of high output voltage.

### 17. Monitor switch (MONITOR)

Toggles between use and nonuse of the monitor input terminals (MONITOR) on the rear panel.

on : Enables to reproduce the data from the recorder.  
(monitor indicator off)

off : Enables to reproduce the data from the source  
(monitor indicator on) selected with the input selector.

- Every pressing of this switch toggles the monitor on and off.

The monitor indicator lights up when the monitor switch is on.

# Names and Functions

## Display

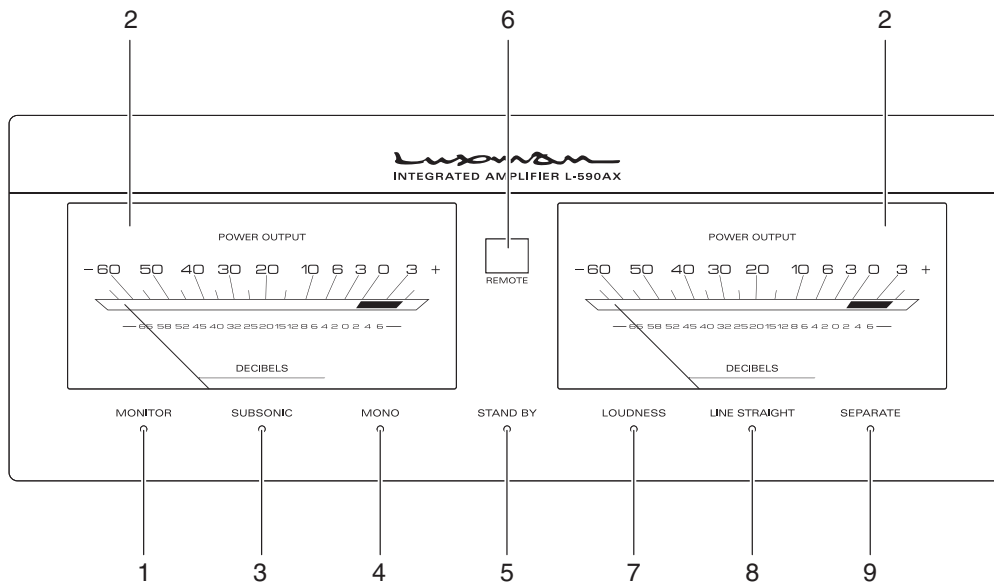

### 1. Monitor indicator (MONITOR)

Lights up when the monitor switch is on.

### 2. Power meters

The left meter reads the output of the L channel, and the right meter reads the output of the R channel. The meters read the level in decibels.

The meters light when the power is on.

### 3. Subsonic indicator (SUBSONIC)

Lights up when the subsonic switch is on.

### 4. Monaural indicator (MONO)

Lights up when the monaural switch is on.

---

The subsonic, monaural and loudness can be toggled only from the accessory remote control (RA-17).

---

**5. Standby indicator (STAND BY)**

Lights up when the AC plug is plugged into a wall socket and the operation switch is set to off.

This indicator turns off when the AC plug is disconnected from the wall socket or the power switch is set to on. This indicator blinks when the protection circuit is activated.

**6. Remote sensor (REMOTE)**

Receives signals from the accessory remote control.

**7. Loudness indicator (LOUDNESS)**

Lights up when the loudness switch is on.

**8. Line straight indicator (LINE STRAIGHT)**

Lights up when the line straight switch is on.

---

When the line straight switch is set to on, the subsonic, monaural and loudness cannot be adjusted from the accessory remote control.

When one of these switches is pressed, the line straight indicator blinks for 3 seconds to show that this unit cannot be operated.

Adjust the subsonic, monaural or loudness after setting the line straight switch to off.

---

**9. Separate indicator (SEPARATE)**

Lights up when the separate switch is on.

---

The subsonic, monaural and loudness can be toggled only from the accessory remote control (RA-17).

---

# Names and Functions

## Rear panel

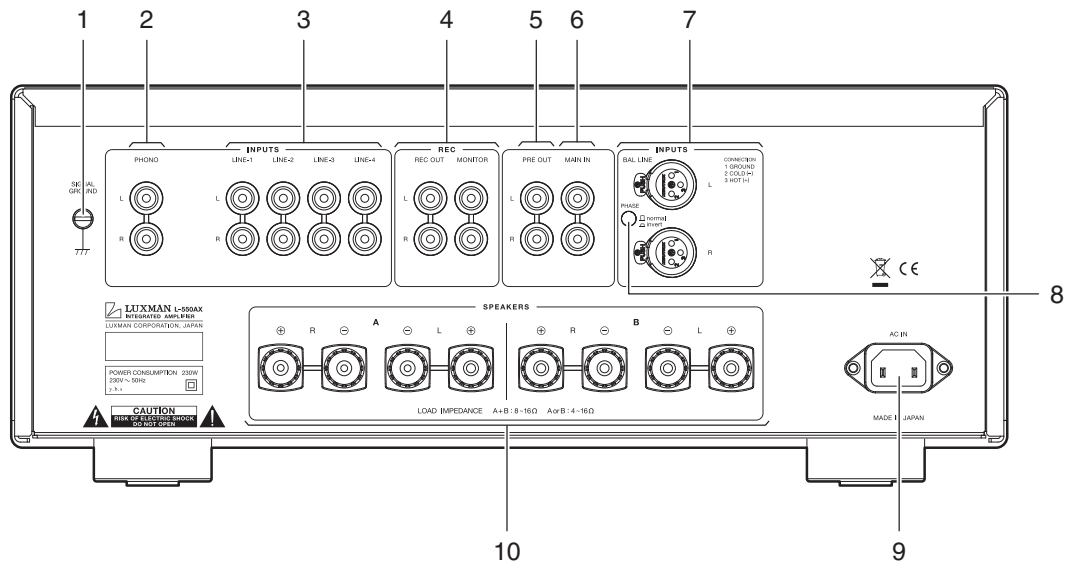

### 1. Signal ground (ground terminal) (SIGNAL GROUND)

Is a ground terminal for devices to be connected to this unit. This terminal is used to reduce noise when other devices are connected. This terminal is designed not for safety.

### 2. Phono input terminal (PHONO)

Is an input terminal to connect an analog record player.

Do not connect a CD player or other devices whose output level is high.

Normal playback cannot be achieved due to sound crack.

### 3. LINE-1, LINE-2, LINE-3, and LINE-4 input terminals (unbalance) (LINE-1, LINE-2, LINE-3, LINE-4)

Are used for high-level signal inputs from a CD player, an SACD player, a tuner, a DVD player, a TV, and other such devices. The input sensitivity is 180 mV, and the impedance is 42 kohms. These input terminals offer the same functions.

### 4. Recorder input/output terminals (REC)

Connect the audio input/output of a recorder. The audio input of a recorder is connected to REC OUT, and the audio output of a recorder is connected to MONITOR.

Do not insert shortpin plugs into REC OUT.

No sound is generated.

### 5. Pre-out terminal (PRE OUT)

This terminal is used to obtain the output of the preamplifier. A bi-amp connection can be performed with a combination of an external power amplifier because this terminal always provides output regardless of the separate switch setting.

---

**Do not insert shortpin plugs into PRE OUT.  
No sound is generated.**

---

### 6. Main in terminal (MAIN IN)

Provides input to the main-amplifier section when the pre-amplifier and main-amplifier are separated by setting the separate switch to on.

### 7. Balance input terminals (BAL LINE)

Are the balance type input terminals of the LINE level for an XLR connector (Cannon connector).

### 8. Phase inverters (PHASE)

Change the phase when the balance input terminal is used. The phase shall be corresponding to the phase of the input device.

- |  |          |
|--|----------|
| <input type="checkbox"/> Normal position | ① GROUND |
|  | ② COLD   |
|  | ③ HOT    |
| <input type="checkbox"/> Invert position | ① GROUND |
|  | ② HOT    |
|  | ③ COLD   |

### 9. AC inlet (AC IN)

Connects the accessory power cable. The power shall be supplied from a household wall socket.

### 10. Speaker terminals (SPEAKERS)

Connects a speaker system.

The right speaker terminal shall be connected to the R side, and the left speaker terminal shall be connected to the L side in consideration of the polarity.

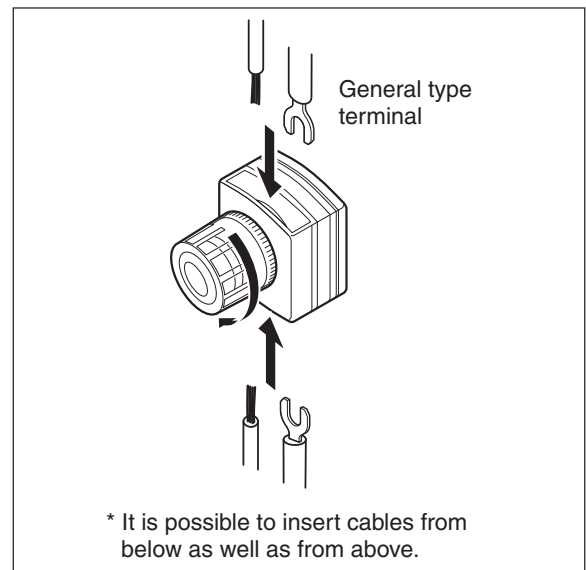

# Connections

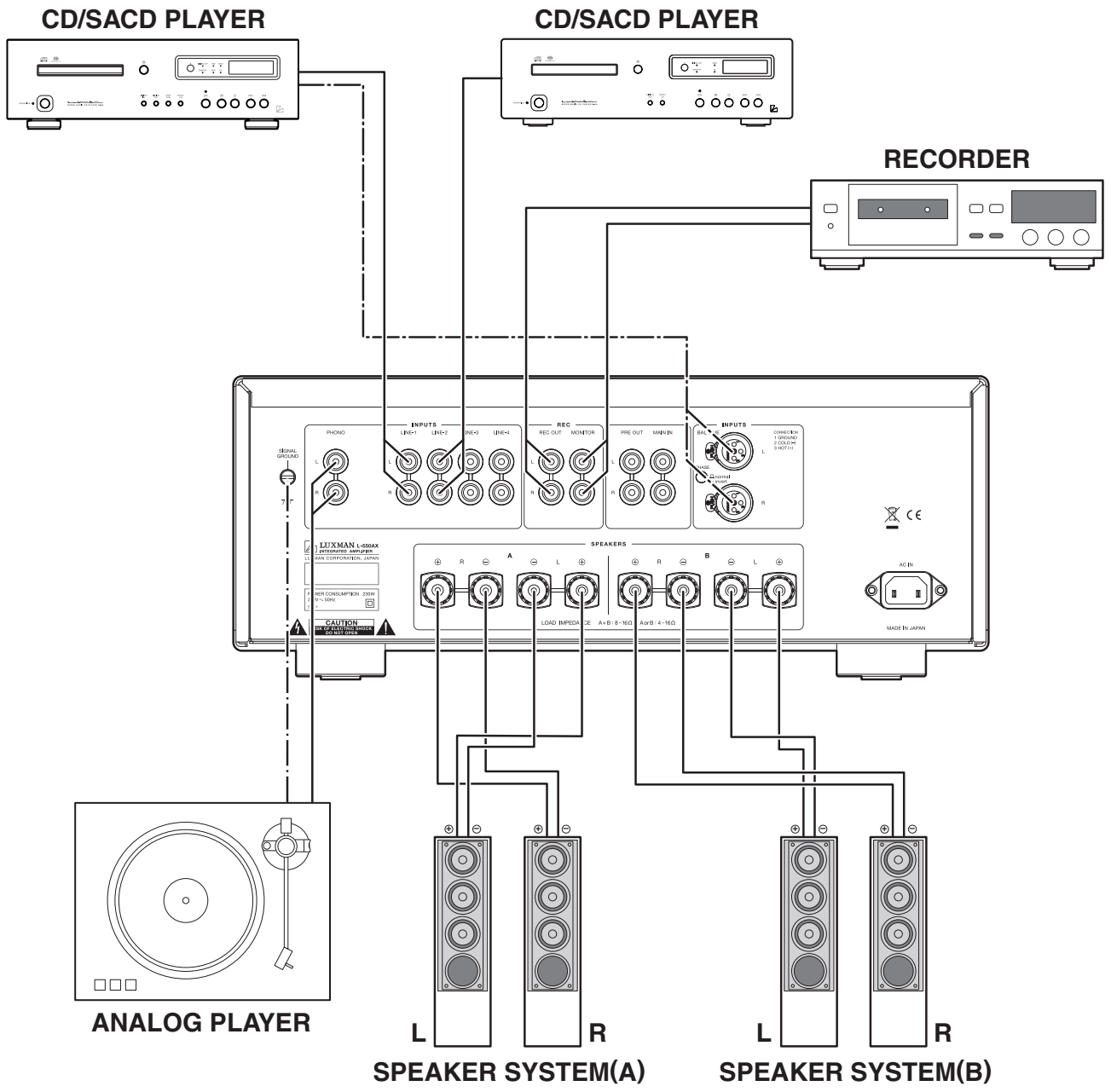

### How to connect power supply

Use the accessory power cable and insert the AC plug in an outlet on the wall in the room where the unit will be installed.

### How to connect CD player, SACD player, tuner, or other devices

Connect between the output terminals of a CD player, an SACD player, a tuner, or other such input devices and the LINE-1 input terminals of this unit with 2 (R and L) pin-plug cables or balanced cables.

For LINE-2, LINE-3, and LINE-4 input terminals, connection in the same fashion as the LINE-1 terminals provides the reproduction likewise.

### How to connect speakers

Connect the left-channel speaker to the LEFT SPEAKER terminal of this unit and the right-channel speaker to the RIGHT SPEAKER terminal.

Securely connect the  $\oplus$  terminal of the speaker system to the speaker terminal  $\oplus$  (red) of this unit, and the  $\ominus$  terminal of the speaker system to the speaker terminal  $\ominus$  (black) of this unit.

If the  $\oplus$  and  $\ominus$  terminals are reversely connected to either of the right and left speaker systems, the acoustic phases of the sound reproduced from the right and left speaker systems are also reversed. In such a case, be aware that the sound level in the low range will be reduced and the acoustic stability will worsen, thus failing in normal stereo playback.

# Connections

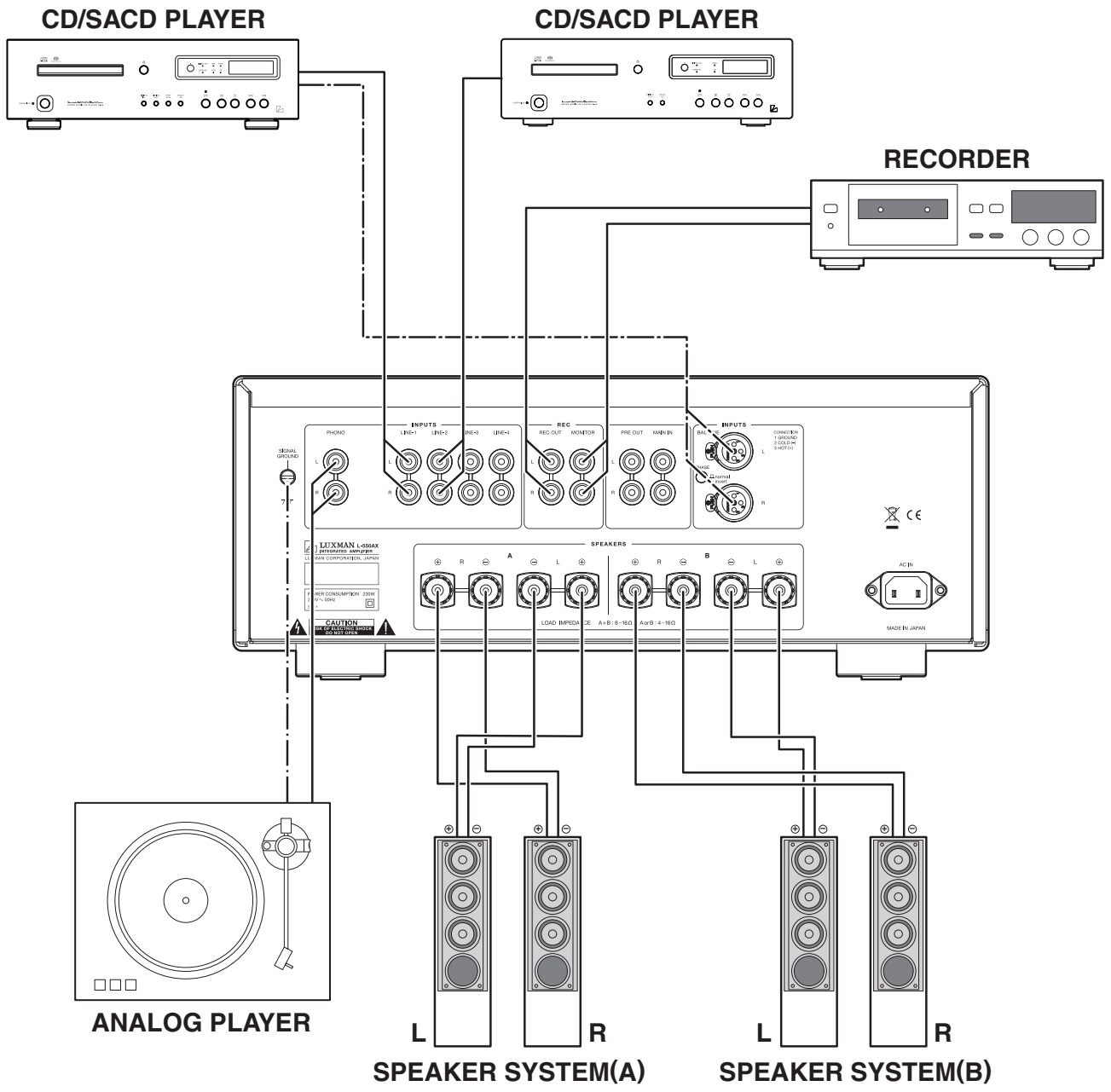



## How to connect record player

Connect between the output terminal of an analog record player and the PHONO terminal of this unit with 2 (R and L) pin-plug cables.

For some types of players, the ground wire from the phono motor or the tone arm should be connected to the ground terminal of this unit.

The phono equalizer of this unit uses the MM or MC cartridge. If an MC cartridge with low output voltage is used, set the cartridge selector on the front panel to the MC position.

---

The output from a record player equipped with a phono equalizer or from an independent phono equalizer shall be connected to the line input terminals of this unit.

---

## How to connect recorder

### 1. Connection to monitor terminal (playing)

Connect between the line output terminals (LINE OUT) of a recorder and the monitor terminals of this unit with pin-plug cables in consideration of R and L. Now, setting the monitor switch on the front panel or the remote control to on provides playback.

### 2. Connection to REC OUT terminal (recording)

When the sound source from the various input devices is reproduced, which are connected to the PHONO or LINE terminals of this unit, setting the recording switch to on allows users to provide the REC OUT terminal with the signal. Connection between the REC OUT terminal of this unit and the line input terminals (LINE IN) of the recorder with pin-plug cables is required for recording on the recorder. After the connection, you can enjoy listening to the sound from the speaker system and record the sound at the same time. These output signals for recording are not affected by the control functions such as the volume control and tone control functions.

---

When you need not toggle an input source to be recorded (especially when a recorder connected to the recorder output terminals is recording), do not operate this switch. Do not insert shortpin plugs into REC OUT. No sound is generated.

When a CD recorder, tape recorder, or other devices are connected, be aware that the playback sound volume becomes low or no sound is generated if the device extremely decreases the impedance of the line input terminals of the recorder or causes short-circuit on the line input terminals or if the recording switch is set to on.

---

## How to connect PRE OUT/MAIN IN terminal

Either the pre-amplifier or main-amplifier can be separately used.

When the pre-amplifier or main-amplifier is separately used, set the separate switch on the front panel to on.

When only the pre-amplifier is used, connect the PRE OUT terminal of this unit to the input terminal of another power-amplifier, and when only the main-amplifier is used, connect the MAIN IN terminal of this unit to the output terminal of another power-amplifier.

---

When this amplifier is used without separating between pre-amplifier and main-amplifier, set the separate switch on the front panel to off, or no sound is generated.

Do not insert shortpin plugs into PRE OUT. No sound is generated.

---

# Operations

## Before operation

1. Ensure that the connections are correctly performed. (Normal playback cannot be achieved with wrong connection of R, L, ⊕, or ⊖)
2. When the power is toggled between on and off or the input selector is changed over, set the volume control to the minimum position in advance.

## Playback procedure

1. Press the operation switch after ensuring that the volume control is set to the minimum position.
2. Select a source to be reproduced with the input selector.
3. Adjust the sound level with the volume control.
4. Operate the line straight switch, balance control, and tone control according to the reproduced source.

## How to operate line straight switch

The line straight switch is used to play sound with the shortest signaling route for enhancing the purity of the source selected with the input selector. When this switch is set to on, the balance control, tone control, subsonic, monaural and loudness are bypassed.

## How to operate balance control

The balance control allows users to adjust the balance of sound volume between right and left channels. When the balance adjustment is not required, the balance control is set to the center position.

---

**When the line straight switch is set to on, the balance control does not function.**

---

## How to operate the tone control

This unit has the tone control function for the low-frequency and high-frequency ranges.

The low-frequency range type works in the 300 Hz or lower. The tone control is set to flat frequency characteristic at the center position. Rotating the control clockwise causes the low-frequency range to be enhanced, and rotating the control counterclockwise causes the low-frequency range to be attenuated.

The high-frequency range type works in the 3 kHz or higher. As with the low-frequency range type, the tone control is set to flat frequency characteristic at the center position. Rotating the control clockwise causes the high-frequency range to be enhanced, and rotating the control counterclockwise causes the high-frequency range to be attenuated.

For both the low-frequency and high-frequency ranges, the right and left channels interlockingly function.

---

**When the line straight switch is set to on, the tone control does not function.**

---

## How to record a source

1. Select a source to be recorded with the input selector.
2. Set the recording switch to on.
3. Play the source to be recorded and set the recorder to the recording state.

- \* Operation of the tone control or balance control does not affect the recording signals.
- \* The recording switch works when the power is on.

### Procedure of timer-controlled recording

1. Turn on the operation switch to activate this unit.
2. Select a source to be recorded under timer control with the input selector.
3. Set the recording switch to on.
4. Perform time setting for start and stop times with your timer.
5. Refer to the operating instructions of the timer and other connected devices for further information.

---

**If the volume control is not set to low levels, the source selected with the input selector may be reproduced from the speakers. Be sure to set the volume control to a low level.**

**When timer-controlled recording is performed, operations of the amplifier are the same as regular use.**

---

### Procedure of timer-controlled playing

1. Turn on the operation switch to activate this unit.
2. Select a source to be reproduced under timer control with the input selector.
3. Adjust the volume level with the volume control.
4. Perform time setting for start and stop times with your timer.
5. Refer to the operating instructions of the timer and other connected devices for further information.

### Memory

This unit stores the following items when the power is off:

Item	To be stored
INPUT	Selected source
METER	on/off
MONITOR	on/off
SUBSONIC	on/off
MONO	on/off
LOUDNESS	on/off
LINE STRAIGHT	on/off
SEPARATE	on/off

### Memory reset

The following operations restore all the settings to the factory defaults.

- (1) Turn off the power of this unit.
- (2) Hold down the operation switch on the main unit for 5 seconds or more and press the line straight switch on the main unit once, and the power state switches from on to off.

That's all for memory reset.

Factory default

Item	Default
INPUT	LINE-1
METER	on
MONITOR	off
SUBSONIC	off
MONO	off
LOUDNESS	off
LINE STRAIGHT	off
SEPARATE	off

# How to Use Remote Control

## Remote control (RA-17)

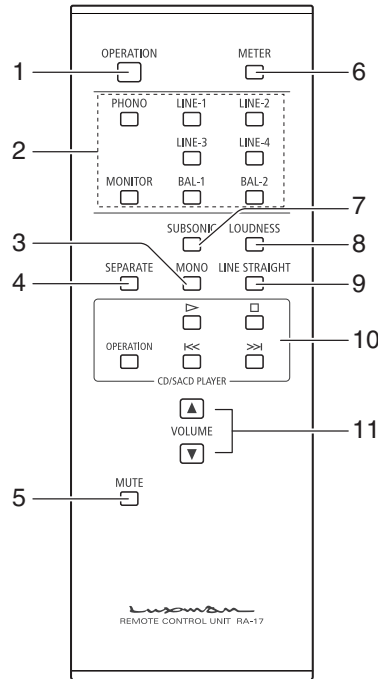

### 1. Operation switch (OPERATION)

Toggles the power on and off.

When wiring or connection is performed, be sure to turn off this switch.

### 2. Input selector (LINE-1, LINE-2, LINE-3, LINE-4, BAL-1, BAL-2, PHONO, MONITOR)

Selects an input terminal from among the unbalanced input terminals on the rear panel consisting of LINE-1, LINE-2, LINE-3, LINE-4, PHONO, and MONITOR or the balanced input terminal consisting of BAL LINE.

\* The balanced input terminal (BAL LINE) can be selected by pressing either of BAL-1 or BAL-2.

### 3. Monaural switch (MONO)

Mixes the signals from right and left channels. The monaural indicator lights up when this switch is pressed.

Pressing this button again to turn off the monaural switch allows regular stereophonic reproduction.

\* When the line straight switch is set to on, this switch does not function.

### 4. Separate switch (SEPARATE)

Separates the pre-amplifier and main-amplifier each other.

off : Uses this unit as a normal pre-main amplifier.  
(separate indicator off)

on : Feeds external signals from the MAIN IN terminal on the rear panel to the main-amplifier section.

- Holding down this switch for 1 second toggles the separate switch on and off.

The separate indicator lights up when the separate switch is on.

### 5. Mute switch (MUTE)

Activates the mute function and blinks the power-on indicator resulting in no sound generated.

Pressing this button again to set the mute function to off allows sound to be generated.

### 6. Meter switch (METER)

Turns off the meter lights.

Pressing this switch again turns on the meter lights again.

## 7. Subsonic switch (SUBSONIC)

Cuts ultra-low frequencies out of audible range to prevent ultra-low range noise from adversely affecting audible range. This function is significantly effective especially when a record is warped or a woofer is shaking owing to ultra-low range vibration.

- Every pressing of this switch toggles the subsonic on and off.

The subsonic indicator lights up when the subsonic switch is on.

- \* When the line straight switch is set to on, this switch does not function.

## 8. Loudness switch (LOUDNESS)

Psychoacoustically compensates the frequency characteristics when the volume control is set to the center position or lower.

This compensation allows listeners to complement human listening characteristics when the sound volume is in the low level.

- Every pressing of this switch toggles the loudness on and off.

The loudness indicator lights up when the loudness switch is on.

- \* When the line straight switch is set to on, this switch does not function.

## 9. Line straight switch (LINE STRAIGHT)

Enhances the purity of the sound quality by bypassing the balance control circuit, tone control circuit, or the like.

off : Line straight off/bypass off  
(line straight indicator off)

on : Line straight on/bypass on  
(line straight indicator on)

- Every pressing of this switch toggles the line straight on and off.

The line straight indicator lights up when the line straight switch is on.

## 10. CD/SACD player operation switch (CD/SACD PLAYER)

This switch is used to control the corresponding CD/SACD players.

---

As of October 2010, the corresponding CD/SACD players are D-08, D-06, D-05, D-10, D-7, D-600, and D-700S.

---

## 11. Volume (VOLUME, ▲, ▼)

This button is used to adjust the sound volume. The sound volume is lowered with ▼ and raised with ▲.

## Remote control

The remote control shall be aimed at the remote sensor of this unit within the specified angle range shown in the illustration when used.

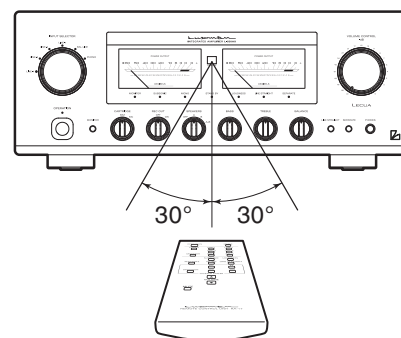

Effective distance: approx. 5 m

## Dry cell

### [How to load batteries]

1. Put your finger on the battery cover claw on the rear of the remote control, and slide the cover downward to open it.
2. Put 2 AAA batteries in the battery case as shown in the illustration.
3. Close the battery cover.

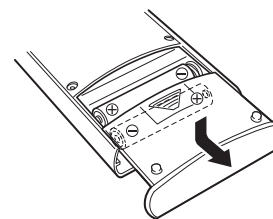

- \* When the batteries start to lose power, the effective distance becomes shorter or the unit does not function even though the switch is pressed. In such a case, both of the batteries shall be replaced with new ones at the same time.

- \* If the remote control is not used for a long time, the batteries shall be removed from the case.

# Block Diagram

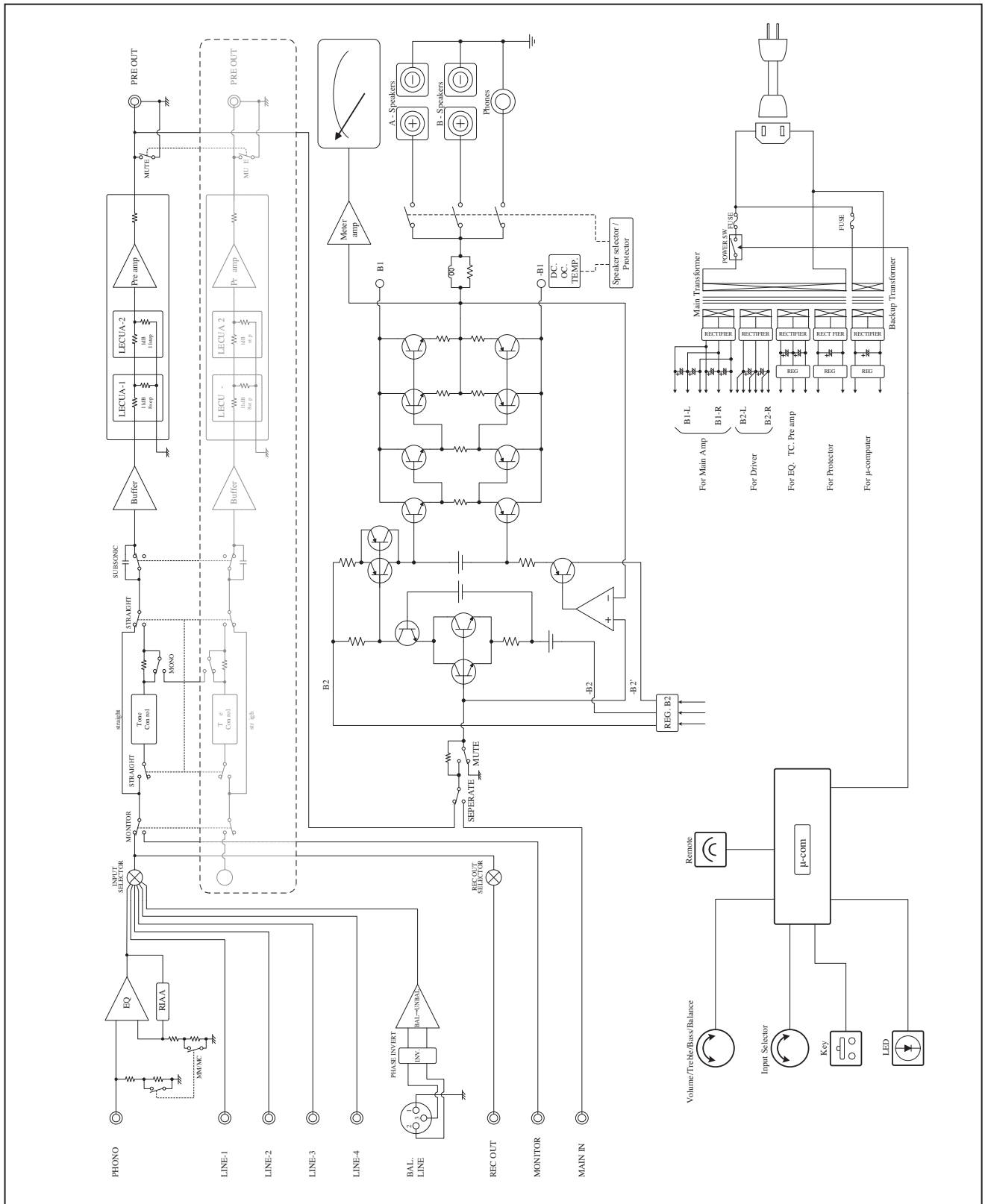

# Specifications

  
INTEGRATED AMPLIFIER L-550AX

<b>Continuous power output</b>	20 W + 20 W (8 Ω) 40 W + 40 W (4 Ω)	
<b>Total harmonic distortion</b>	0.007% (8 Ω, 1 kHz both channels simultaneous drive, line straight on) 0.02% (8 Ω, 20 Hz to 20 kHz both channels simultaneous drive, line straight on)	
<b>Pre-amplifier</b>	PHONO (MM)	: 2.5 mV / 47 kΩ
<b>Input sensitivity/input impedance</b>	PHONO (MC)	: 0.3 mV / 100 Ω
	LINE	: 180 mV / 42 kΩ
	MONITOR	: 180 mV / 42 kΩ
	BAL. LINE	: 180 mV / 79 kΩ
<b>Main-amplifier</b>	MAIN-IN	: 450 mV / 47 kΩ
<b>Input sensitivity/input impedance</b>		
<b>Output voltage</b>	REC OUT	: 180 mV
	PRE-OUT	: 1 V
<b>S/N ratio</b>	PHONO (MM)	: 91 dB or more (IHF-A weighted, 5 mV input, line straight on)
	PHONO (MC)	: 75 dB or more (IHF-A weighted, 0.5 mV input, line straight on)
	LINE	: 105 dB or more (IHF-A weighted, input shorted, line straight on)
<b>Frequency response</b>	PHONO (MM)	: 20 Hz to 20,000 Hz (±0.5 dB, line straight on)
	PHONO (MC)	: 20 Hz to 20,000 Hz (±0.5 dB, line straight on)
	LINE	: 20 Hz to 100,000 Hz (within -3 dB, line straight on)
<b>Tone control</b>	Max. amount of change	BASS : ±8 dB at 100 Hz TREBLE : ±8 dB at 10 kHz
<b>Loudness control</b>	100 Hz	: +7 dB
	10 kHz	: +5 dB
<b>Damping factor</b>	: 160	
<b>Accessories</b>	<ul style="list-style-type: none"> <li>· Remote control RA-17</li> <li>· Owner's Manual</li> <li>· size "AAA" batteries (2)</li> <li>· Power cable</li> <li>· Safety cautions</li> </ul>	
<b>Power supply voltage</b>	230 V ~ (50 Hz)	
<b>Power consumption</b>	230 W 0.4 W (at standby), 170 W (at no input)	
<b>Max. external dimensions</b>	440 (W) × 178 (H) × 454 (D) mm	
<b>Weight</b>	24.3kg (main unit only)	

\* Specifications and appearance are subject to change without notice.

# Before Asking for Repair Services

While the unit is used, an unusual phenomenon may be confused as a malfunction for a certain reason. Prior to asking us for repair services, please check the table below and read the instruction manual for the subsidiary devices. If the cause of the malfunction cannot be identified, please contact your dealer.

Problem	Cause	Solution
No power is supplied even though the operation switch is pressed.	· The power plug is disconnected from the wall outlet, or it is not completely inserted.	· Insert the power plug in the wall outlet securely.
	· The power plug is disconnected from the AC inlet, or it is not completely inserted.	· Insert the power plug in the AC inlet securely.
No sound is generated.	· The volume control is set to the minimum level.	· Rotate the volume control clockwise to adjust the sound volume.
	· The input selector is not set to the source to be reproduced.	· Set the input selector to the source to be reproduced.
	· Cable connections are incomplete.	· Make cable connections securely.
	· The output level of the input device is set to the minimum position.	· Adjust the output level.
	· The separate switch is set to on.	· Set the separate switch to off.
	· The mute switch of the remote control is set to on.	· Set the mute switch to off.
No sound is generated on one side.	· The balance control is fully rotated.	· The balance control shall be set to the center position under normal conditions.
	· The connecting cable is not connected on one side only.	· Make cable connections securely.
Humming sound (boon or zzz noise) is generated.	· The ground side of the pin-plug cable has no contact with the terminal.	· Make connections securely so that the ground side of the pin-plug cable can be connected.
	· The ground wire of the record player is not connected.	· Connect the ground wire of the record player to the GND terminal.
	· Connections or mounting conditions are incomplete between the cartridge and shell, or between the shell and tone arm of the record player.	· Connect (or mount) the cartridge, shell, and tone arm securely.
No effect of tone control or balance control is observed.	· The line straight switch is set to on.	· When tone control or balance control is used, the line straight switch shall be set to off.
The subsonic, monaural or loudness is not activated.	· The line straight switch is set to on.	· When the subsonic, monaural or loudness is used, the line straight switch shall be set to off.
The lights of the power meters are not turned on.	· The meter switch is set to off.	· Set the meter switch of the remote control to on.
The separate switch of the remote control is not activated.	· To prevent incorrect operations, this unit is designed to toggle the separate on/off by holding down the separate switch approximately for approx. 1 second.	· Hold down the separate switch of the remote control for approx. 1 second.



**MEMO**

*Luxman*  
INTEGRATED AMPLIFIER L-550AX

# MEMO



